

**PLAN OF MicroFAST UNIT IN PYRAMID PRECAST STRUCTURE**

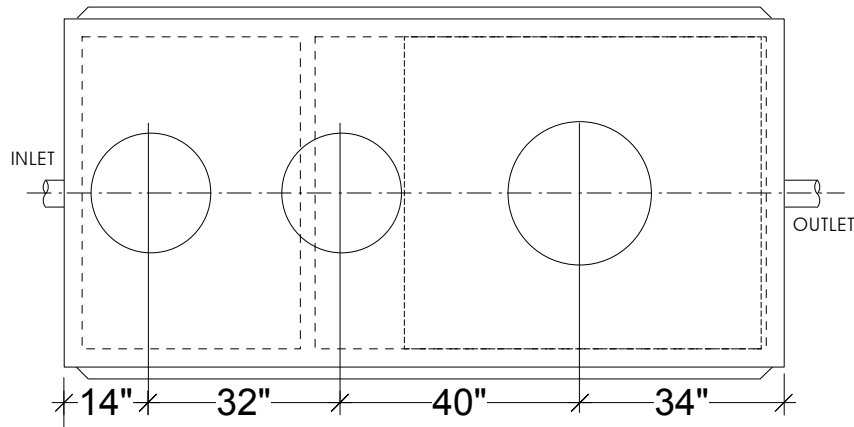

**NOTES**

1. MicroFast UNITS ARE INSTALLED IN-PLANT TO THE MANUFACTURERS INSTRUCTIONS AND GUIDELINES AND BY PERSONNEL INSTRUCTED BY THE MANUFACTURER
2. MicroFast 0.90 UNITS ARE LISTED BY NSF INTERNATIONAL UNDER BIO-MICROBICS
3. THIS UNIT IS RATED FOR USE IN NON-TRAFFIC AREAS
4. MINIMUM EXCAVATION SIZE: 11' LENGTH - 6' 6" WIDTH

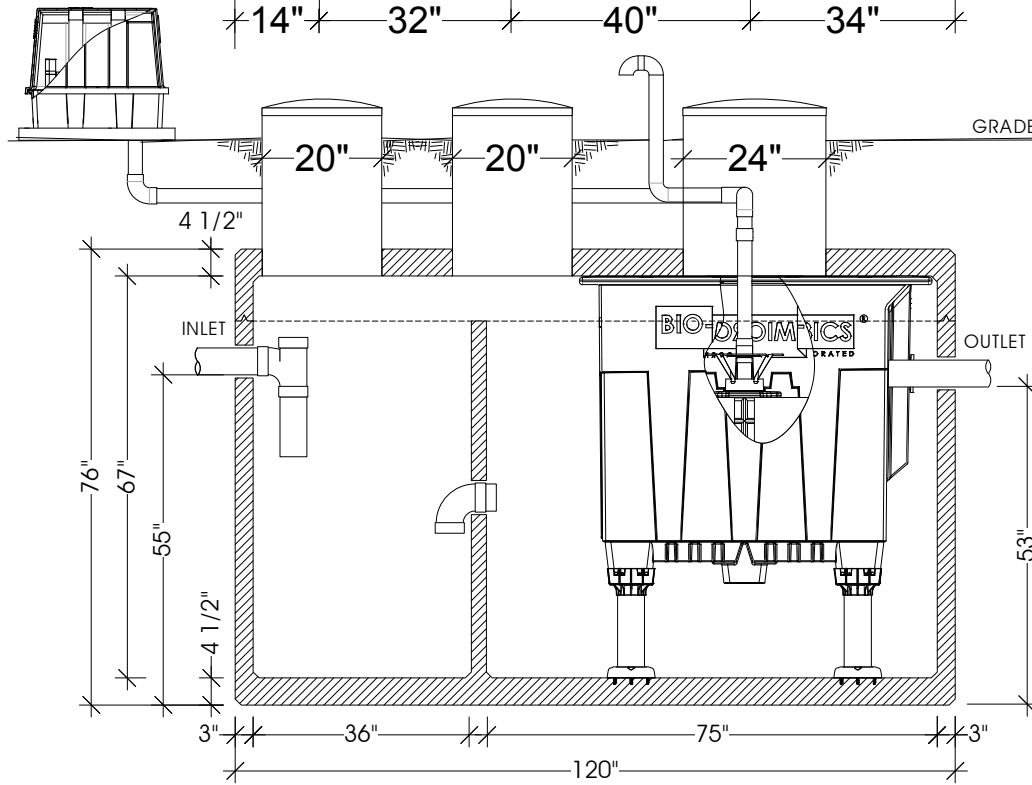

**SIDE SECTION**  
**MicroFAST UNIT IN PYRAMID PRECAST STRUCTURE**

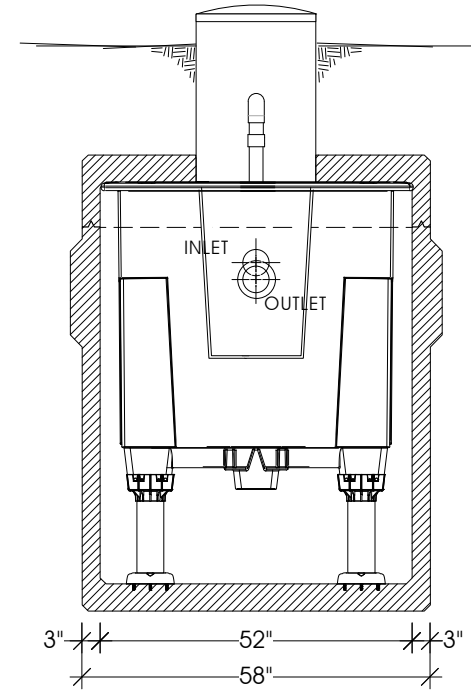

**END SECTION**  
**MicroFAST UNIT IN PYRAMID PRECAST STRUCTURE**

**MicroFAST® 0.90 FAST Unit**  
**Mounted in Pyramid Precast Unit**



2438 LOCUST AVE. RIALTO, CA PH. (909) 823-4255 FAX (909) 823-8687

- \* INDUSTRIAL WASTE CLARIFIERS
- \* SAND AND GREASE INTERCEPTORS
- \* SEPTIC TANKS & DISTRIBUTION BOXES

DRAWING #  
PPMF090 v3

DRAWN BY  
SCOTT BENART

SCALE  
1:32